



TM

LIGHTING SOLUTIONS



2023 - 2024

OFF-ROAD PRODUCT GUIDE





# LIGHTING SOLUTIONS



With the introduction of **Lighting Solutions**, DB Link has started a new era for LED enthusiasts. We develop and manufacture our products to withstand the elements associated with the rigorous outdoors. We stand behind our newly created LED technology and cutting edge design.



LIGHTING  
SOLUTIONS

[www.DBLINKLIGHTINGSOLUTIONS.com](http://www.DBLINKLIGHTINGSOLUTIONS.com)

LED Light Bar Highlights.....	4
LED Light Bars.....	7
Curved LED Light Bars.....	8
LED Spot / Flood Lights.....	10
LED Bar Specifications.....	12
LED Single Row Extreme Light Bars.....	14
LED Single Row Light Bars.....	15
Marine LED Lights.....	16
LED Surface Mount Flood Lights.....	18
LED Work Lights.....	19
RGB LED Lighting.....	22
RGB Dual Row RGB Light Bars.....	26
LED Universal Bar Mount Brackets.....	28
LED Bar Mount Brackets.....	30
LED Light Bar Accessories.....	38
LED Light Strip Accessories.....	40
LED Strobe Light Module.....	41
LED Ghost Light.....	43

# TABLE OF CONTENTS

# LIGHT BAR HIGHLIGHTS

\* Images displayed are for illustration purposes only and may differ from actual photos

**High Output Optical Lens**  
designed reflective lens harnesses  
and amplifies the LED LUX strength



**Weather Proof Chassis**  
Gasket infused sealing to ensure  
a 100% waterproof chassis



**Polycarbonate Lens**  
Shatterproof polycarbonate  
lens with High PSI impact  
strength



**Low Current consumption**  
delivers superior lighting capabilities  
without overloading your electrical  
system



**Worry Free Technology**  
4 Plex Chip design to ensure  
uninterrupted thermal controlled  
LED performance



**Extended LED life cycle**  
High output CREE LEDs with  
65,000 + hours usable lifespan



Full Colored Giftbox

\* Images displayed are for illustration purposes only and may differ from actual photos

### Efficient Heat Sink Design

Oversized heat sink keeps CREE LED's running cooler, brighter for longer lasting performance.



### IP 67 Element Rated Housing

Ensures seamless performance in any type of environment or weather condition

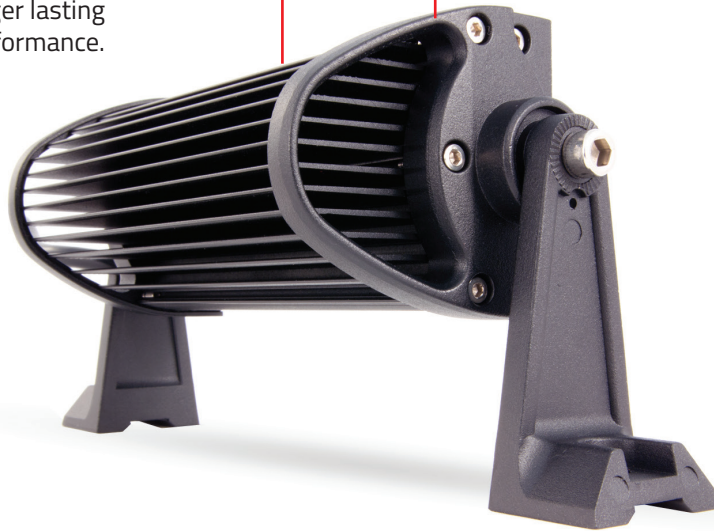

### Type III Black Hard coat anodizing

an Anti- corrosive protective finish that ensures a high end finish for years to come



### Universal Mounting

Brackets slide horizontally and pivot vertically for optimal adjustment while rubber feet control vibration



### Rust Free Anti-corrosive hardware

Stainless steel assembly bolts and mounting hardware



# LIGHT BAR HIGHLIGHTS

Contact Us (877) 787 - 0101



**LIGHTING**  
SOLUTIONS

\* Images displayed are for illustration purposes only and may differ from actual photos

## LED Light Beam Patterns

LED Spot Beam

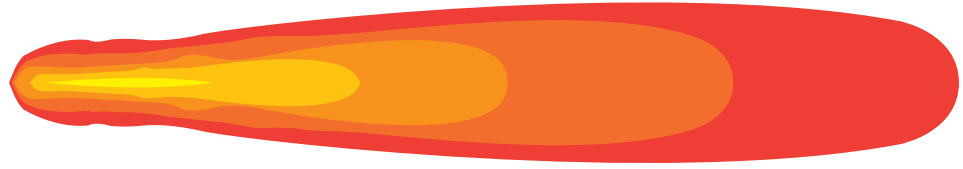

LED Flood Beam

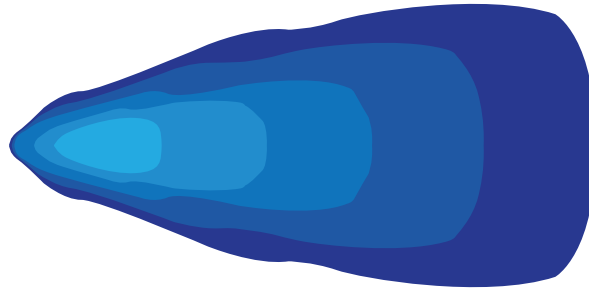

LED Combo Beam

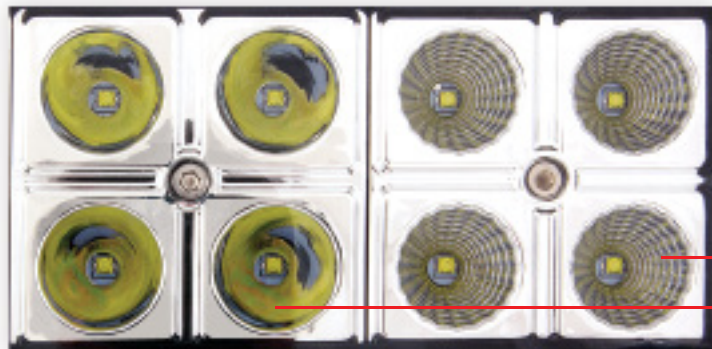
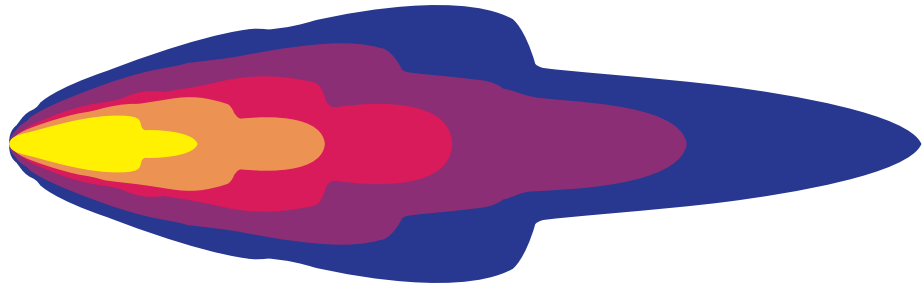

**Combo Beam Pattern**

120 Degree Floods

8 Degree Spots

\* Images displayed are for illustration purposes only and may differ from actual photos

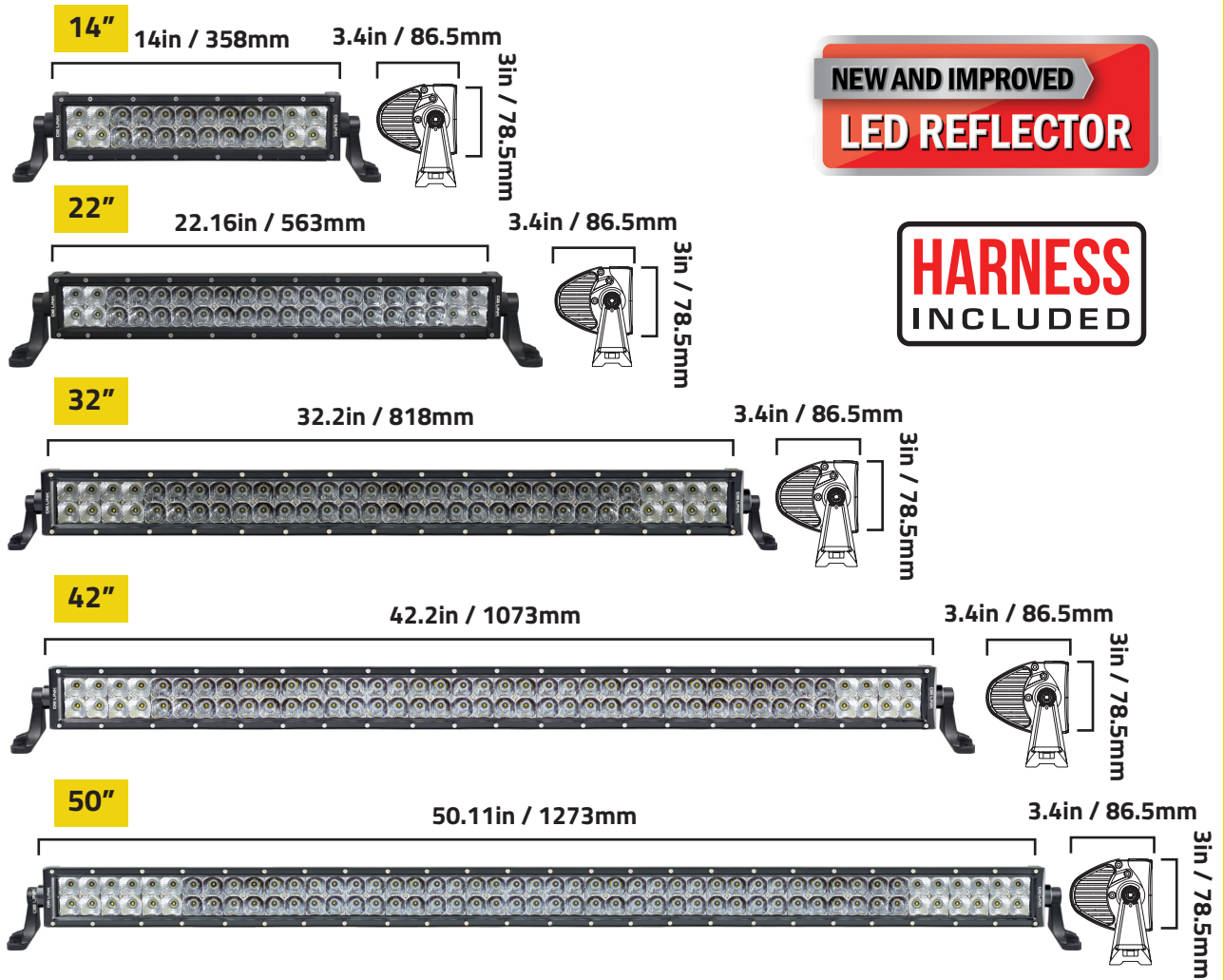

# LED LIGHT BARS

## Combination Spot / Flood Lighting Pattern Light Bar

- High Power CREE LED Light bar
- Combination Spot / Flood Lighting Pattern
- IP67 Element Rating
- High Output CREE LED's
- Black Extruded Aluminum Chassis



MODEL	LED DESCRIPTION	WATTS	LEDS	SIZE	M. CARTON
DBLB14C	16 Spot / 8 Flood	72	24	14"	6
DBLB22C	32 Spot / 8 Flood	120	40	22"	6
DBLB32C	44 Spot / 16 Flood	180	60	32"	4
DBLB42C	64 Spot / 16 Flood	240	80	42"	4
DBLB50C	72 Spot / 24 Flood	280	96	50"	4

Contact Us (877) 787 - 0101



**LIGHTING SOLUTIONS**

# CX CURVED OFF-ROAD L.E.D. LIGHT BARS

\* Images displayed are for illustration purposes only and may differ from actual photos



Side View

## Our CX Curved Off-Road L.E.D. Light Bars

mimic the radius contour of most windshields and front bumpers found on ATV, UTV, trucks and SUVs for a seamless integration. Designed with a curved chassis and narrow beam LED lens, the CX Light Bars focus on long range distances with a wider light dispersion allowing them to illuminate everything in and around the forward path



Top View



Front View



\* Images displayed are for illustration purposes only and may differ from actual photos

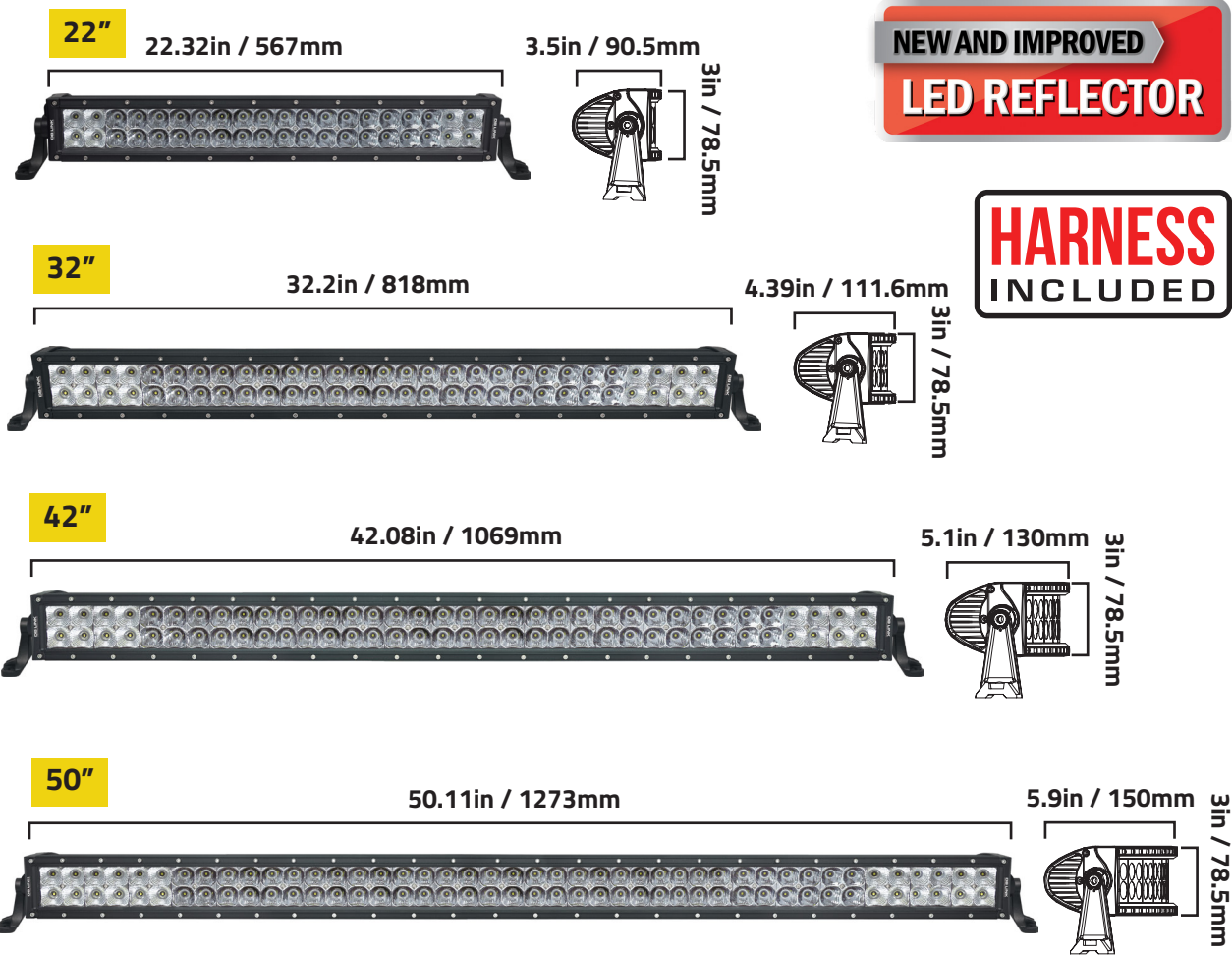

## Spot / Flood Lighting Pattern Curved Light Bar

- High Power CREE LED Light bar
- Combination Spot / Flood Lighting Pattern
- IP67 Element Rating
- High Output CREE LED's
- Black Extruded Aluminum Chassis



MODEL	LED DESCRIPTION	WATTS	LEDS	SIZE	M. CARTON
DBLB22CX	32 Spot / 8 Flood	120	40	22"	6
DBLB32CX	44 Spot / 16 Flood	180	60	32"	4
DBLB42CX	64 Spot / 16 Flood	240	80	42"	4
DBLB50CX	72 Spot / 24 Flood	288	96	50"	4

Contact Us (877) 787 - 0101



**CX CURVED OFF-ROAD L.E.D. LIGHT BARS**

**WORK LIGHTS**



**8" LED LIGHTS**

**3 WATT LEDS**



IP67 Element Rating ■ High Output CREE LED's ■ Black Extruded Aluminum Chassis ■ Shockproof Electronics ■ 10v-30v DC Operating Voltage ■ Shatterproof Polycarbonate Lens ■ 36 Watts

MODEL	LED DESCRIPTION	SOLD AS	LEDS	SIZE	M. CARTON
DBLB8F	Flood Light	Single	12	8"	6
DBLB8S	Spot Light	Single	12	8"	6
DBLB8C	4 Spot / 8 Flood	Single	12	8"	6

\* Images displayed are for illustration purposes only and may differ from actual photos



DBLB8C-K : Sold as pair

MODEL	DESCRIPTION	SOLD IN	LEDS	SIZE	M. CARTON
DBLB8C-K	Spot/Flood Light kit	Pairs	12	8"	6

Sold: in Pairs



## 4" LED LIGHT KITS



DBSM4S-K : Sold as pair



DBSM4F-K : Sold as pair



- IP67 Element Rating
- Output CREE LED's
- Black Extruded Aluminum Chassis
- Shockproof Electronics
- 10v-30v DC Operating Voltage
- Shatterproof Polycarbonate Lens
- 12 Watts

MODEL	DESCRIPTION	SOLD IN	LEDS	SIZE	M. CARTON
DBSM4S-K	Spot Surface Mount	Pairs	4	4"	8
DBSM4F-K	Flood Surface Mount	Pairs	4	4"	8

Contact Us (877) 787 - 0101



# LED. SPOT AND FLOOD LIGHTS

\* Images displayed are for illustration purposes only and may differ from actual photos

## LED LIGHT BAR SPECIFICATIONS



DB Link Model	Beam Pattern	Weight (LBS)	Output Watts 24V	Amp Draw 24V
DBSM4S-K	Spot	1.9	26.30W	24V/1.096A
DBSM4F-K	Flood	1.9	26.30W	24V/1.096A
DBLB8C-K	Combo	3.4	53W	24V/2.208A
DBLB8C	Combo	1.5	26.9W	24V/1.121A
DBLB8S	Spot	1.5	26.9W	24V/1.121A
DBLB8F	Flood	1.5	26.9W	24V/1.121A
DBLB14C	Combo	2.3	56.68W	24V/2.362A
DBLB22C	Combo	3.3	90.98W	24V/3.791A
DBLB32C	Combo	4.6	139.20W	24V/5.800A
DBLB42C	Combo	5.9	170.40W	24V/7.100A
DBLB50C	Combo	7.2	206.88W	24V/8.620A
DBLB22CX	Combo	3.4	90.98W	24V/3.791A
DBLB32CX	Combo	4.3	139.20W	24V/5.800A
DBLB42CX	Combo	6	170.40W	24V/7.100A
DBLB50CX	Combo	7.2	206.88W	24V/8.620A
DBLSR12C	Combo	2.5	50.4W	24V/2.1A
DBLSR22C	Combo	3.5	84W	24V/3.5A
DBLSR32C	Combo	9.5	117.6W	24V/4.9A
DBLSR42C	Combo	12.2	168.W	24V/7A

\* Images displayed are for illustration purposes only and may differ from actual photos



# LED BAR SPECIFICATIONS

Output Watts 12V	Amp Draw 12V	Total LEDs	Raw Lumens	Harness
26.6W	12V/2.217A	8	1080	DBLHD1
26.6W	12V/2.217A	8	1080	DBLHD1
51.5W	12V/4.292A	24	5280	DBLHD1
28.56W	12V/2.380A	12	2640	DBLHD1
28.56W	12V/2.380A	12	2640	DBLHD1
28.56W	12V/2.380A	12	2640	DBLHD1
50.53W	12V/4.211A	24	5280	DBLHD1
93.48W	12V/7.790A	40	8800	DBLHD1
146.4W	12V/12.200A	60	13200	DBLHD2
178.80W	12V/14.900A	80	17600	DBLHD2
215.16W	12V/17.930A	96	21120	DBLHD2
93.48W	12V/7.790A	40	8800	DBLHD1
146.4W	12V/12.200A	60	13200	DBLHD2
178.8W	12V/14.900A	80	17600	DBLHD2
215.16W	12V/17.930A	96	21120	DBLHD2
51.12W	12V/4.26A	6	5400	DBLHD1
85.2W	12V/7.1A	12	10800	DBLHD1
118.8W	12V/9.9A	18	16200	DBLHD2
170.4W	12V/14.2A	24	21600	DBLHD2

Contact Us (877) 787 - 0101

\* Images displayed are for illustration purposes only and may differ from actual photos

**5.5"** 5.5in / 140mm



**9"** 9in / 236mm



2 in / 50.8mm

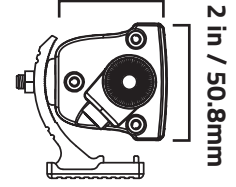

Side profile sizes for all models

**20.5"** 20.5in / 524mm



**Single Wiring Harness with New Rocker Switch Included!**

**32"** 32in / 812mm



**39.5"** 39.5in / 1004mm



**51"** 51in / 1292mm



## Spot/Flood Lighting Pattern Single Row Bars

- High Power LED Light bar
- Combination Spot / Flood Lighting Pattern
- IP 67 Element Rating
- High Output 3 Watt OSRAM LED's
- Black Extruded Aluminum Chassis

**HARNESS INCLUDED**

**GERMAN ENGINEERED OSRAM LED'S**

**IP67**  
Waterproof LED Light Bar

**Shatterproof Polycarbonate Lens**

**Waterproof Wire Harness Included**

MODEL	LED DESCRIPTION	WATTS	LEDS	SIZE	M. CARTON
DBSRX5.5S	Spot	3	3	5.5"	12
DBSRX9S	Spot	3	6	9"	12
DBSRX20.5C	Combo Spot/Flood	3	15	20.5"	6
DBSRX32C	Combo Spot/Flood	3	24	32"	6
DBSRX39.5C	Combo Spot/Flood	3	30	39.5"	6
DBSRX51C	Combo Spot/Flood	3	39	51"	4

\* Images displayed are for illustration purposes only and may differ from actual photos

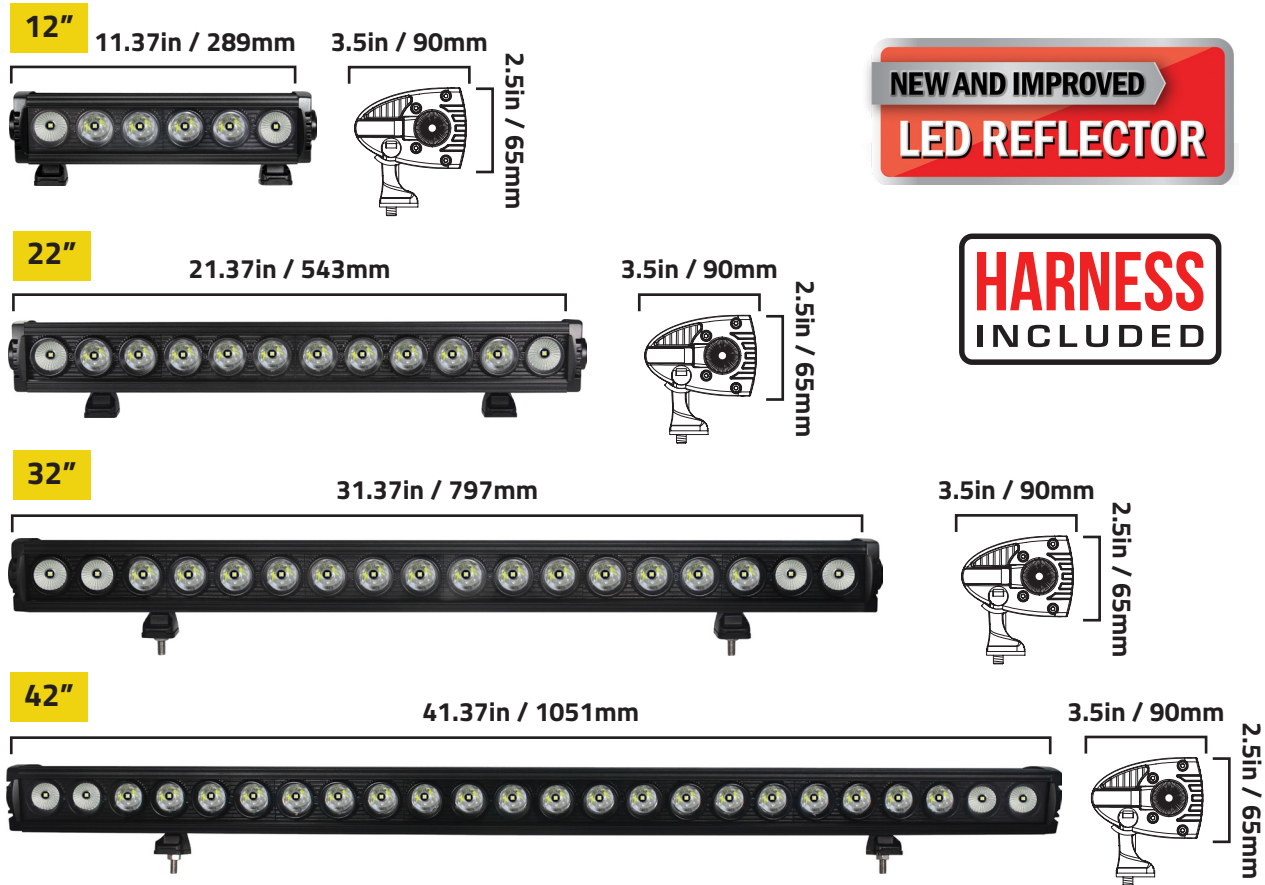

# LED SINGLE ROW LIGHT BARS

## Spot/Flood Lighting Pattern Single Row Bar

- High Power LED Light bar
- Combination Spot / Flood Lighting Pattern
- IP 67 Element Rating
- 10 Watt High Output CREE LED's
- Black Extruded Aluminum Chassis

### 10 WATT LEDS



MODEL	LED DESCRIPTION	WATTS	LEDS	SIZE	M. CARTON
DBLSR12C	4 Spot / 2 Flood	60	6	12"	6
DBLSR22C	10 Spot / 2 Flood	120	12	22"	6
DBLSR32C	14 Spot / 4 Flood	180	18	32"	4
DBLSR42C	20 Spot / 4 Flood	240	24	42"	4



Side View



Rear View

Contact Us (877) 787 - 0101



\* Images displayed are for illustration purposes only and may differ from actual photos

# Spot / Flood Lighting Pattern Single Row Bars

**9"**

21.37in / 543mm



**20.5"**

31.37in / 797mm



**51"**

41.37in / 1051mm



- High Power LED Light bar
- Combination Spot / Flood Lighting Pattern
- IP 67 Element Rating
- High Output 3 Watt OSRAM LED's
- White Extruded Aluminum Chassis

2in / 50.8mm

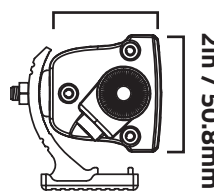

2in / 50.8mm



MODEL	LED DESCRIPTION	WATTS	LEDS	SIZE	M. CARTON
DBSRX9F-M	Flood	3	6	9"	12
DBSRX20.5F-M	Flood	3	15	20.5"	6
DBSRX51C-M	Combo Spot/Flood	3	39	51"	4



\* Images displayed are for illustration purposes only and may differ from actual photos

**LED - MARINE LIGHTS**

## DBSM4F-M

### 4" LED Flood Light

- IP67 Element Rating ▪ High Output CREE LED's
- 316 grade Stainless Steel bracket ▪ Shockproof Electronics 10v-30v DC Operating Voltage
- Shatterproof Polycarbonate Lens
- 12 Watts ▪ Harness not Included



**3 WATT LEDS**



**MARINE**



**IP67**  
Waterproof LED Light Bar



**CREE**  
Super Bright LED's



Shatterproof Polycarbonate Lens



Waterproof Wire Harness Included

MODEL	DESCRIPTION	SOLD AS	LEDS	SIZE	M. CARTON
DBSM4F-M	Flood Surface Mount	Single	4	4"	18

## DBLB8F-M

### 8" LED Flood Light

- IP67 Element Rating ▪ High Output CREE LED's
- 316 grade stainless steel screws on bezel and mounting hardware ▪ Shockproof Electronics
- 10v-30v DC Operating Voltage
- 36 Watts ▪ Harness not Included

13941154



**3 WATT LEDS**



**MARINE**



**IP67**  
Waterproof LED Light Bar



**CREE**  
Super Bright LED's



Shatterproof Polycarbonate Lens



Waterproof Wire Harness Included

MODEL	DESCRIPTION	SOLD AS	LEDS	SIZE	M. CARTON
DBLB8F-M	Flood Mount	Single	12	8"	6

## DBSR6F-M

### 6" Single Row LED Light

- IP67 Element Rating ▪ High Output LED's
- 316 grade stainless steel screws on mounting hardware
- Shockproof Electronics ▪ 10v-30v DC Operating Voltage
- 18 Watts ▪ Harness not Included



**3 WATT LEDS**



**MARINE**



**IP67**  
Waterproof LED Light Bar



**HIGH OUTPUT**  
LED's



Shatterproof Polycarbonate Lens



Waterproof Wire Harness Included

MODEL	DESCRIPTION	SOLD AS	LEDS	SIZE	M. CARTON
DBSR6F-M	Flood Mount	Single	6	6"	20

Contact Us (877) 787 - 0101



**LIGHTING SOLUTIONS**

## MULTIPLE APPLICATIONS



WHITE



RED



GREEN



AMBER



BLUE



Surface Base Mount



Tubular Base Mount

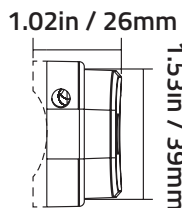
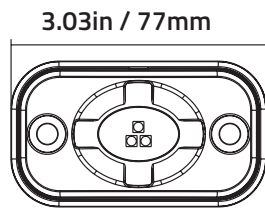

- High Power Led Flood Light
- Flat Surface/Tube Mount Bases Included
- Ip67 Element Rating
- 3 High Output Cree LEDs
- Polycarbonate Lens

- Shock Proof Electronics
- 10V-30V Dc Operating Voltage
- 30,000 Hours Avg Lifetime
- Shatter Proof Polycarbonate Lens
- Harness Not Included

MODEL	COLOR	DESCRIPTION	SOLD AS	LEDS	M. CARTON
DBSM15BL1	Blue	Flood Mount	Single	3 x 5 watts	20
DBSM15W1	White	Flood Mount	Single	3 x 5 watts	20
DBSM9A1	Amber	Flood Mount	Single	3 x 3 watts	20
DBSM9G1	Green	Flood Mount	Single	3 x 3 watts	20
DBSM9R1	Red	Flood Mount	Single	3 x 3 watts	20
DBSM15BL2	Blue	Flood Mount	Pair	3 x 5 watts	16
DBSM15W2	White	Flood Mount	Pair	3 x 5 watts	16
DBSM9A2	Amber	Flood Mount	Pair	3 x 3 watts	16
DBSM9R2	Red	Flood Mount	Pair	3 x 3 watts	16
DBSM9G2	Green	Flood Mount	Pair	3 x 3 watts	16

\* Images displayed are for illustration purposes only and may differ from actual photos



- 3" Driving Light
- 20 Watt Output
- Element Rating IP67
- 4-5W High Power CREE LEDs
- Die-cast Aluminum Housing
- Polycarbonated Lens
- Stainless Steel Mounting Brackets



## DBSM3.0S-K

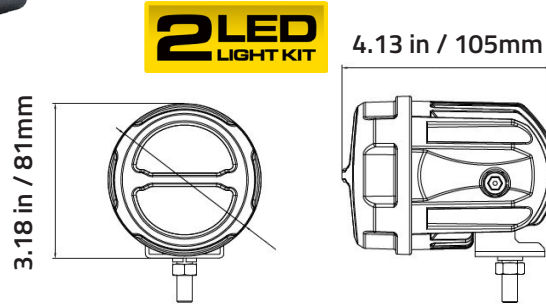

MODEL	DESCRIPTION	SOLD IN	LEDS	SIZE	M. CARTON
DBSM3.0S-K	3" Diameter Spot	Pairs	4	3"	8



- 3.5" Driving Light
- 18 Watt Output
- Element Rating IP67
- 6-3W High Power LEDs
- Die-cast Aluminum Housing
- Polycarbonated Lens
- Stainless Steel Mounting Brackets



## DBSM3.5S-K

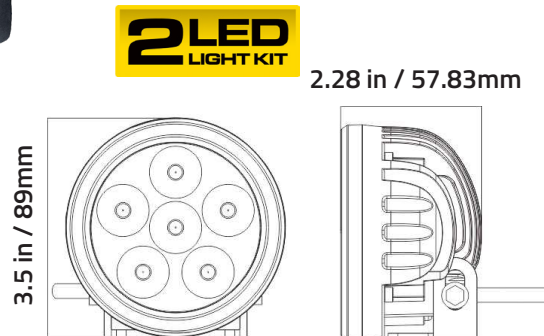

MODEL	DESCRIPTION	SOLD IN	LEDS	SIZE	M. CARTON
DBSM3.5S-K	3.5" Diameter Spot	Pairs	6	3.5"	8

Contact Us (877) 787 - 0101

# WORK LIGHTS

Element Rating: IP67

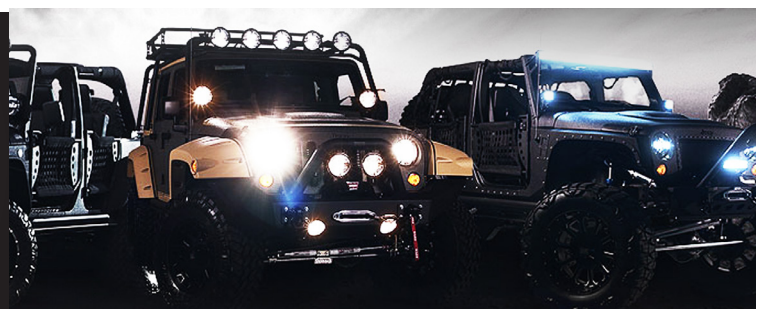

3.11 in / 79mm

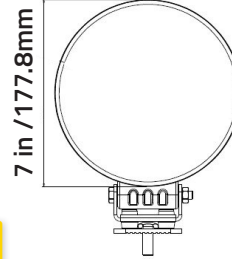
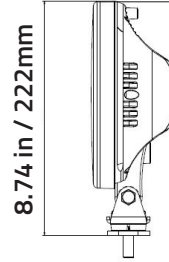

- 60 Watt output
- Operating Voltage: 12-24V DC
- Element Rating: IP 67
- 6 - 10w High Power CREE LEDS
- Current 12V/3.67A, 24V/1.83A
- Body Color: Black
- 6000K Color Temperature
- Die-cast aluminum housing
- Polycarbonate Lens
- Stainless Steel Mounting Bracket
- Secondary outer light ring

**60 WATTS**  
10 WATT LEDS



## DBSM7D 7" Round Driving Light

MODEL	DESCRIPTION	SOLD AS	LEDS	SIZE	M. CARTON
DBSM7D	7" Diameter Spot	Single	6	7"	8



- 60 Watt output
- Operating Voltage: 9-80V DC
- Luminous Flux: 4080 lm
- Element Rating: IP 67
- Current 4A/12V, 2A/24V
- Body Color: Black
- 6500K Color Temperature
- Die-cast aluminum housing
- Polycarbonate Lens
- Stainless Steel Mounting Bracket



## DBSM7C 7" Round Combination Driving Light

MODEL	DESCRIPTION	SOLD AS	LEDS	SIZE	M. CARTON
DBSM7C	7" Diameter Combo	Single	12	7"	8

\* Images displayed are for illustration purposes only and may differ from actual photos



## 25 WATTS



## DB425W

- 4" Driving light
- 25 watt output
- Element Rating IP67
- 1-25W Cree LED
- Die-cast Aluminum Housing
- Stainless Steel Mounting Brackets
- Pair

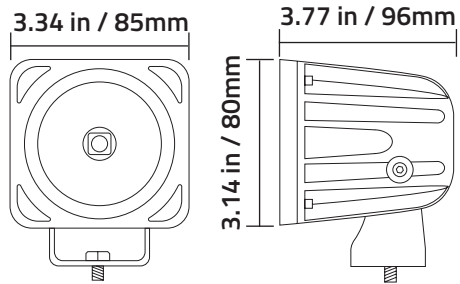

MODEL	DESCRIPTION	SOLD IN	LEDS	SIZE	M. CARTON
DB425W	4" Driving Light	Pairs	1	4"	12



## DBSW24F

- 5" Square Driving light
- 24 Watt Output
- Element Rating IP67
- 8-3W High Power LED's
- Die-cast Aluminum Housing
- Stainless Steel Mounting Brackets
- Pair

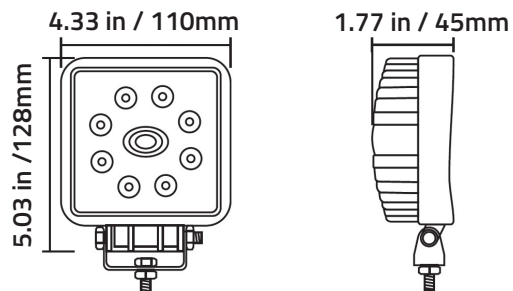

MODEL	DESCRIPTION	SOLD IN	LEDS	SIZE	M. CARTON
DBSW24F	5" Square Driving Light	Pairs	8	5"	8

Contact Us (877) 787 - 0101



**L.E.D. WORK LIGHTS**

\* Images displayed are for illustration purposes only and may differ from actual photos

## 4" Flush Mount Brake/Reverse Lights



**2 COLOR LEDS**  
Sold: in Pairs



Perfect for: Custom Rear Bumpers with flush brake and reverse light function / Trailer brake lights with reverse light function / Custom racks on-pick ups / Back up brake lights for UTV'S and ATV's / Adding extra lighting for reverse lights on RV's / Dual trigger Wiring

### **DBFM4K-BL** 4" Flush Mount Reverse Lights

MODEL	DESCRIPTION	SOLD IN	LEDS	SIZE	M. CARTON
DBFM4K-BL	Flush Mount Reverse Light	Pairs	4	4"	18



**DB LINK  
LED LIGHTING  
SOLUTIONS**

Customize your rear bumpers with flush mount brake and reverse lighting.

\* Modules only controls RGB function of the lights. High power white lights are controlled by separate switch



**Bluetooth**   
Android & iOS Compatible

- Controls multi-color accent lighting
- Controls flash patterns
- Music Beat Mode
- Bluetooth compatibility



**RGB SERIES**

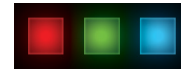

Download the app from iTunes or Google Play

 **RGBC-8**

M. CARTON: 20

**8 Output Bluetooth RGB Control Module**

Maximum Total Output of 30 Watts

 **RGBC-4RF**

M. CARTON: 20

**4 Output RF Wireless RGB Control Module**

Maximum Total Output of 30 Watts



 **RGBC-2RF**

M. CARTON: 250

**Dual Output RGB Controller**

With 28 Key RF Wireless Remote Control



\* Images displayed are for illustration purposes only and may differ from actual photos

## DBSM4D-K-RGB 4" RGB Driving Work Lights



RGB SERIES

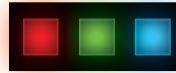

**3 WATT  
LEDS**

Sold: in Pairs



*Must purchase the RGBC-8 / RGBC-4RF / RGBC-2RF Control Module to use RGB functions. (Sold separately.)*

4 x 3 Watt CREE High Power LEDs / 12 Watts total output / 6000K Color Temperature 1080 Lumens / IP67 Element Rating / Operating Voltage: 10- 30 VDC / 65,000 + Hours Lifespan / Die-cast aluminum extrusion Shock & Shatter Proof Electronics / Protective Polycarbonate Lens / Heavy duty swivel track brackets / High Output reflective LED lens / Harness and RGB Harness Sold Separately

MODEL	DESCRIPTION	SOLD IN	LEDS	SIZE	M. CARTON
DBSM4D-K-RGB	4" RGB Work Lights	Pairs	4	1.5" x 2.8"	10

## DBSMRGB-4 RGB Surface Mount LED Accent Lights



**4 LED  
LIGHT KIT**

(4) 3 - 0.5 Watt High Power LEDs / 6 Watts total output / Operating voltage: 10- 30 VDC 30,000 Hours AVG Lifespan / Die-cast aluminum extrusion / Shock Proof Electronics / Polycarbonate Lens



Surface Base Mount



Tubular Base Mount

RGB SERIES



*Must purchase the RGBC-8 / RGBC-4RF / RGBC-2RF Control Module to use RGB functions. (Sold separately.)*

MODEL	DESCRIPTION	SOLD IN	LEDS	SIZE	M. CARTON
DBSMRGB-4	Spot Surface Mount	4 Pieces	3	4"	12



\* Images displayed are for illustration purposes only and may differ from actual photos

## DBWL17DC-3 17" RGB LED Light Wheel Rings - 3 pcs



### SLINGSHOT KIT

- Aluminum LED Wheel Kit with adjustable mounting hardware
- 17in RGB LED color Rings with moving or static light patterns
- Double sided LED rings with IP65 protective cover
- Brake light and turn signal inputs for added functions
- 200 pre-programmed chase patterns
- Smart phone app and wireless RF controller included
- Control lighting and patterns via smart phone app (Multi-color accent lighting controls flash patterns)



REMOTE INCLUDED

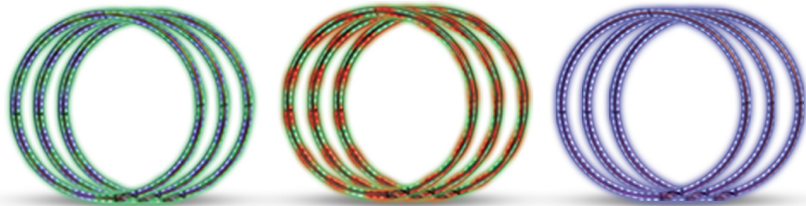

## DBWL17DC-4 17" RGB LED Light Wheel Rings - 4 pcs

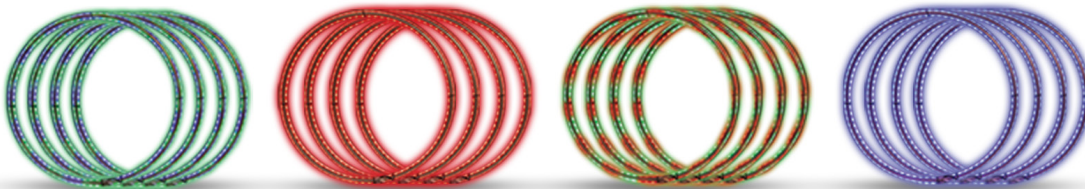

### AUTO KIT

- Aluminum LED Wheel Kit with adjustable mounting hardware
- 17in RGB LED color Rings with moving or static light patterns
- Double sided LED rings with IP65 protective cover
- Brake light and turn signal inputs for added functions
- 200 pre-programmed chase patterns
- Smart phone app and wireless RF controller included
- Control lighting and patterns via smart phone app (Multi-color accent lighting controls flash patterns)



REMOTE INCLUDED



Contact Us (877) 787 - 0101

**db link** LIGHTING SOLUTIONS

RGB L.E.D. LIGHTING

\* Images displayed are for illustration purposes only and may differ from actual photos

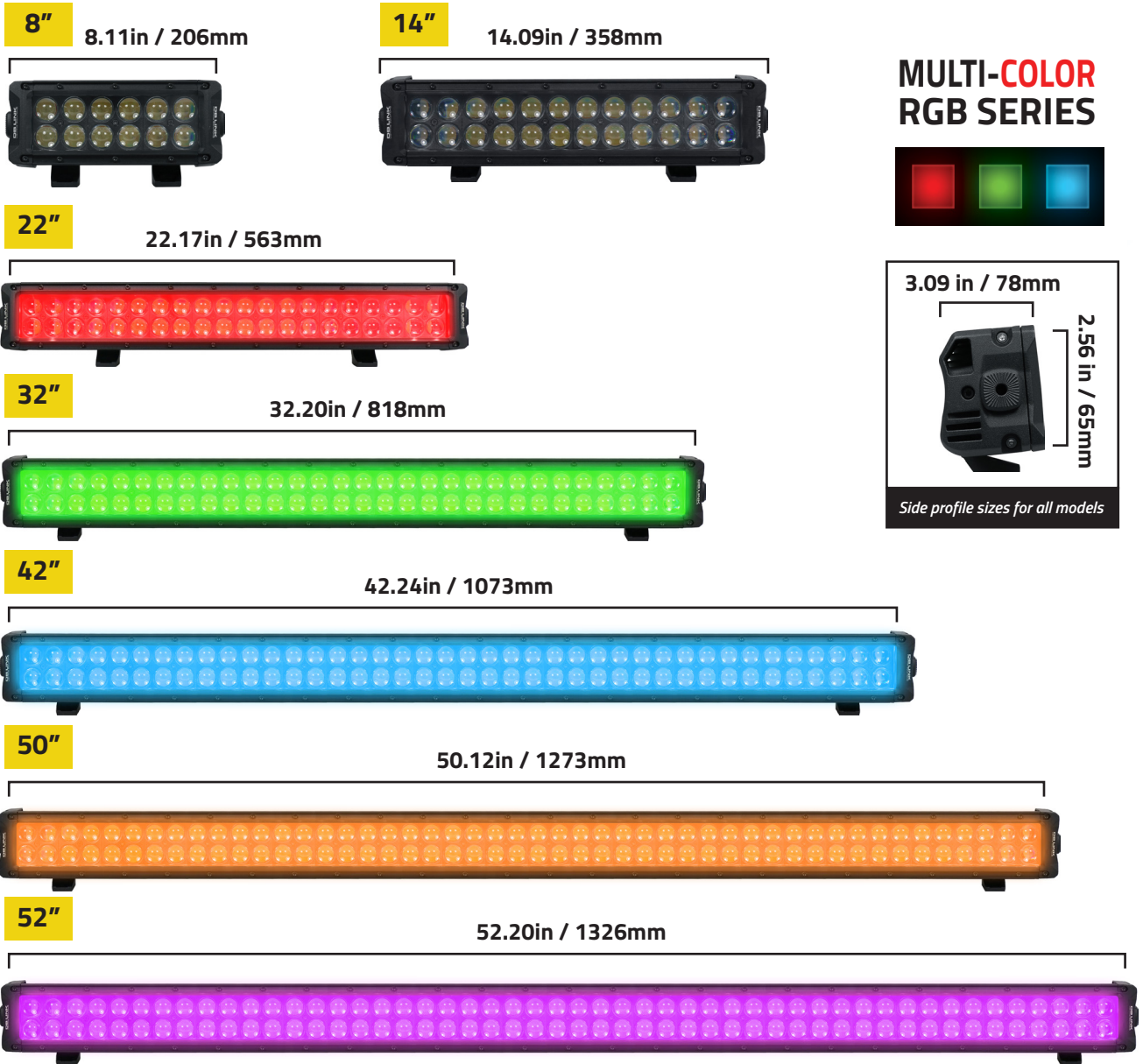

## Spot/Flood Lighting Pattern Single Row Bar

- High Power OSRAM LED Light bar
- Combination Spot / Flood Lighting Pattern
- IP 67 Element Rating
- Bottom - Mount Slide Rail Brackets
- Black Extruded Aluminum Chassis

*Must purchase the RGBC-8 / RGBC-4RF / RGBC-2RF Control Module to use RGB functions. (Sold separately.)*



MODEL	LED DESCRIPTION	WATTS	LEDS	SIZE	M. CARTON
DBLB8RGB	Combo Spot/Flood	18	12	8"	9
DBLB14RGB	Combo Spot/Flood	36	24	14"	9
DBLB22RGB	Combo Spot/Flood	60	40	22"	6
DBLB32RGB	Combo Spot/Flood	90	60	32"	6
DBLB42RGB	Combo Spot/Flood	120	80	42"	4
DBLB50RGB	Combo Spot/Flood	144	96	50"	4
DBLB52RGB	Combo Spot/Flood	150	100	52"	4

\* Images displayed are for illustrative purposes only and may differ from actual photos

## DBRGBH10 10' RGB CONTROLLER EXTENSION HARNESS

MODEL	DESCRIPTION	M. CARTON
DBRGBH10	Extension Harness	100



## DBRGBH3 3' RGB CONTROLLER EXTENSION HARNESS

MODEL	DESCRIPTION	M. CARTON
DBRGBH3	Extension Harness	250



## DBRGBH1 RGB CONTROLLER HARD WIRE HARNESS

MODEL	DESCRIPTION	M. CARTON
DBRGBH1	Hard Wire Harness	1000

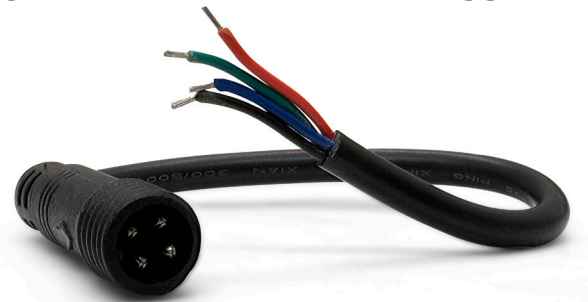

## LED Bar Connection Harnesses

The Lighting Solutions wiring harnesses are designed to connect a single or dual LED light system to your 12V power supply. They feature an inline fuse holder, a pre wired 12Volt relay, and a push button on-off switch. The harnesses are compatible with any of the surface mount or dual row LED bars.

MODEL	DESCRIPTION	M. CARTON
DBLHD2	Single Harness	25
DBLHD1	Single Harness	25
DBLH1-Y	Splitter Harness	100

Harness / Lightbar  
Compatibility  
Reference  
on **pg. 15**

# L.E.D. UNIVERSAL BAR MOUNT BRACKETS

O Mount



Oblique Pillar



Vertical



Horizontal



\* Images displayed are for illustration purposes only and may differ from actual photos

## Universal Mounting Brackets

Our Lighting Solutions Adjustable mounting brackets are an excellent way to mount single or dual row off road LED light bars to your roll cage or your vehicle's tubular mounting locations. We offer simple solutions for mounting onto brush guard bumpers, roof racks, and Roll cages. These Universal bracketing systems can be used on your car, boat or recreational vehicles.

MODEL	DESCRIPTION	M. CARTON
DBB10M	1" O Mount Pair	50
DBB1.250M	1.25" O Mount Pair	50
DBB1.50M	1.5" O Mount Pair	50
DBB1.750M	1.75" O Mount Pair	50
DBB20M	2" O Mount Pair	50
DBB2.50M	2.5" O Mount Pair	50
DBB30M	3" O Mount Pair	50
DBB1.5PM	Oblique pillars Bar Light Mount 1.5"	50
DBB1.75PM	Oblique pillars Bar Light Mount 1.75"	50
DBB20PM	Oblique pillars Bar Light Mount 2"	50
DBB2.5PM	Oblique pillars Bar Light Mount 2.5"	50
DBB3PM	Oblique pillars Bar Light Mount 3"	50
DBB1.5HM	Horizontal Bar Light Mount 1.5"	50
DBB1.75HM	Horizontal Bar Light Mount 1.75"	50
DBB2.5HM	Horizontal Bar Light Mount 2.5"	50
DBB3HM	Horizontal Bar Light Mount 3"	50
DBB1.5VM	Vertical Bar Light Mount 1.5"	50
DBB1.75VM	Vertical Bar Light Mount 1.75"	50
DBB2.5VM	Vertical Bar Light Mount 2.5"	50
DBB3VM	Vertical Bar Light Mount 3"	50

Contact Us (877) 787 - 0101

\* Images displayed are for illustration purposes only and may differ from actual photos

## Jeep Windshield Brackets

Our jeep mount kits are specifically designed to fit the jeep wrangler JK series. These brackets will fit a 50" LED light bar (not Included) over the windshield of your jeep JK using the existing mounting points on the A-pillars. No drilling or cutting required. Our brackets are made from heavy duty, high carbon, stamped steel material and come with a weather resistant black powder coat finish to match your new light bar.



**DBJKWB50S**



**DBJKWB52S**



**DBJKDWB52DS**



MODEL	DESCRIPTION	SOLD IN
DBJKWB50S	07-13 Jeep "JK" Windshield Bracket 50"	Pairs
DBJKWB52S	07-13 Jeep "JK" Windshield Bracket 52"	Pairs
DBJKDWB52DS	07-13 Jeep "JK" Dual Windshield Bracket 52"	Pairs

Due to the variable sizes in different light bar brands, some modification may be required to fit your light bar.

\* Images displayed are for illustration purposes only and may differ from actual photos

Precisely made for the jeep wrangler TJ series. This bracket will fit a 50" LED light bar (not Included) over the windshield of your jeep TJ using the existing mounting points on the A-pillars. No drilling or cutting required. Our brackets are made from heavy duty, high carbon, stamped steel material and come with a weather resistant black powder coat finish to match your new light bar.



MODEL	DESCRIPTION	SOLD IN
DBTJWB501	up to 2002 Jeep TJ Windshield Bracket 50"	Pairs

## Jeep Hood Mounts

Designed to fit with your JK series jeep wrangler, our light bar hood mount allows you to mount 12" or 22" Single row LED light bars (not included) to your hood. No drilling or cutting your hood in any way. Our brackets are made from heavy duty, high carbon, stamped steel material and come with a weather resistant black powder coat finish to match your new light bar. \*Due to the mounting location of this bracket when used on 2013 and up jeep wranglers, interruption of the spray pattern from the windshield washer may occur.

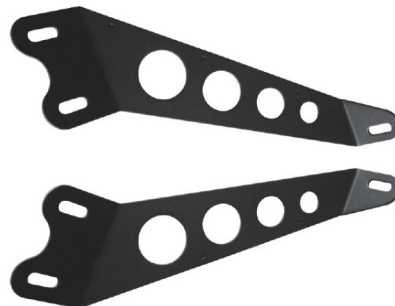

MODEL	DESCRIPTION	SOLD IN
DBJKSR22HM	Jeep "JK" 22" Hood Mount	Pairs
DBJKSR12HM	Jeep "JK" 12" Hood Mount	Pairs

Due to the variable sizes in different light bar brands, some modification may be required to fit your light bar.

Contact Us (877) 787 - 0101



**JEEP LIGHT BAR BRACKETS**

# JEEP LIGHT BAR BRACKETS

\* Images displayed are for illustration purposes only and may differ from actual photos

Our Pillar brackets allow you to install one or two 4" LED surface mounts (not included) onto your JK Jeep Wrangler, connecting to each of your a-pillars. These brackets use existing mounting bolts so no drilling or cutting is required. They are made from high carbon stamped steel material and come with a weather resistant black powder coat finish \*This kit is for jeep jk 07-15 only

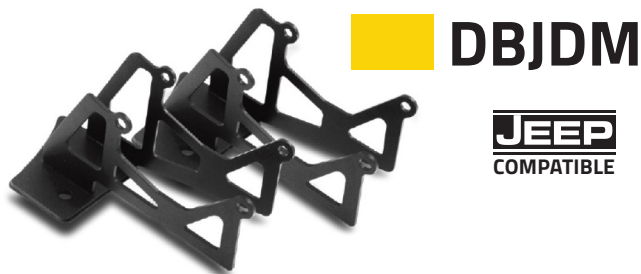
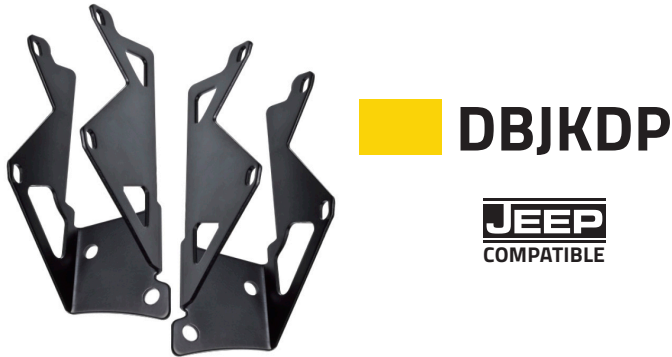

MODEL	DESCRIPTION	SOLD IN
DBJKSP	07-14 Jeep JK Single Pillar 4"	Pairs
DBJKDP	07-14 Jeep JK Double Pillar 4"	Pairs
DBHPM	Jeep Hood Pillar Mount 4" Jeep	Pairs
DBJDM	Dual Pillar Mounts 4"	Pairs

Due to the variable sizes in different light bar brands, some modification may be required to fit your light bar.



\* Images displayed are for illustration purposes only and may differ from actual photos



**Universal Surface Mount**  
**DBUSM**

Ready to add LED bars to your ride. Our universal surface mount brackets easily bolt on to any one of our light bars. They feature full tilt adjustability that put the light output right where you need it. These brackets are made from a heavy duty, high carbon, stamped steel material and come with a weather resistant black powder coat finish to match your new light bar.

MODEL	DESCRIPTION	SOLD IN
DBUSM	Universal Surface Bar Mount	Pairs



**Universal Truck Mount**  
**DBUTM**

Add flare to your truck with our universal roof mount LED bar brackets. Allowing you to mount our 50" LED light bar to the roof of your truck. They are constructed from high carbon stamped steel material and come with weather resistant black powder coat finish. Minor modification may be required to fit your application.

MODEL	DESCRIPTION	SOLD IN
DBUTM	Universal Roof Bar Mount	Pairs

**L.E.D. LIGHT BAR BRACKETS**

Contact Us (877) 787 - 0101





28.5" Length x 2.25" Height

### Universal Bumper Mount

## DBUBM

DB Lighting Solutions has engineered a universal bumper LED mount, allowing you to add complementary LED lighting to any vehicle. They are constructed from high carbon stamped steel material and come with weather resistant black powder coat finish. They are designed to be easily installed with a few simple tools

MODEL	DESCRIPTION
DBUBM	Universal Bumper Mount Bracket



### Universal X Bracket

## DBXHB



Our new X-Mount brackets gives you an inventive way to mount your LED lights. X-Mount brackets are constructed to fit a diameter tubing of 1.25 – 2 inches. Each are made from cast aluminum alloy and feature weather resistant black powder coat finish. X-mounts sold in pairs

MODEL	DESCRIPTION
DBXHB	Universal X Horizontal Bracket

\* Images displayed are for illustration purposes only and may differ from actual photos



**DBLB8B**



**8" Bracket**



**DBLB14B**



**14" Bracket**



**DBLB22B**



**22" Bracket**



**DBLB32B**

**32" Bracket**



Weather Resistant Black Power Coating ■ High Carbon Stamped Steel Material ■ Heavy Duty Bracket ■ Easy Install

MODEL	DESCRIPTION
DBLB8B	8" LED Light Bar Bracket
DBLB14B	14" LED Light Bar Bracket
DBLB22B	22" LED Light Bar Bracket
DBLB32B	32" LED Light Bar Bracket

Give your vehicle a unique look with our Universal U brackets. These brackets can be used on multiple flat surfaces; such as your headache rack, bumper, or truck bed. They are constructed from high carbon stamped steel material and come with weather resistant black powder coat finish. They are designed to be easily installed with a few simple tools

Contact Us (877) 787 - 0101



# LED LIGHT BAR BRACKETS

\* Images displayed are for illustration purposes only and may differ from actual photos



Universal ATV Mount

## ■ DBUHM



Our new Universal ATV handlebar brackets allow you to use LED light bars as headlights. Connecting this bracket to ATVs handlebar permits the light bars to move in the direction your handlebar moves, projecting the light where needed. Our brackets are made from heavy duty, high carbon, stamped steel material and come with a weather resistant black powder coat finish to withstand the rigors of outdoor use.



## ■ DBATVM

MODEL	DESCRIPTION
DBUHM	ATV Universal Handle Bar Mount
DBATVM	ATV Handle Bar Mount

## ■ Side Mount Light Bar Brackets

- LED light bar bracket mounting hardware



MODEL	DESCRIPTION	M. CARTON
DBLBMH	Side Mount Light Bar Brackets	100

\* Images displayed are for illustration purposes only and may differ from actual photos

## Light Bar Rubber Wind Isolators

- Snap in between cooling fins to reduce vibration noise when driving at higher speeds

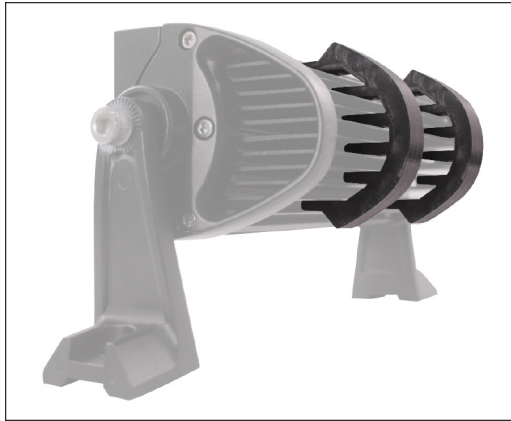

MODEL	DESCRIPTION	M. CARTON
DBLFP1	Rubber Wind Isolators	100

## License Plate Light Bar Mount

DB Link's Universal LED Light License Plate Mount makes it possible for you to securely mount any type of LED light bar to any vehicle with a direct replacement license plate mount.



MODEL	DESCRIPTION	M. CARTON
DBULPM	Universal Light Bar License Plate Mount	20

Contact Us (877) 787 - 0101

\* Images displayed are for illustration purposes only and may differ from actual photos

## Tamper Proof Light Bar Bolts

Adds Security to your Light bars ▪ Dome Shaped Bolt Head Eliminates Tampering ▪ 4 Tamper proof bolts ▪ 1 Fastening Tool

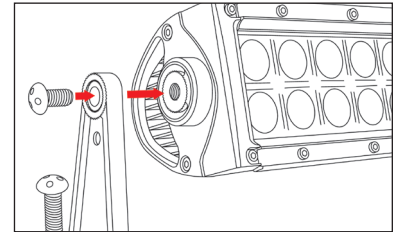

MODEL	DESCRIPTION	M. CARTON
DBLBTPK	Light Bar Bolts	200

## Illuminated Push Button Switch

LED ▪ 19mm ▪ 6 Amps @ 12V ▪ 1.5" Length x 3/4" Diameter ▪ Black Alluminum

MODEL	COLOR	DESCRIPTION	M. CARTON
DBLB19M-LEDR	Red	Momentary	240
DBLB19M-LEDB	Blue	Momentary	240
DBLB19M-LEDW	White	Momentary	240

MODEL	COLOR	DESCRIPTION	M. CARTON
DBLB19F-LEDR	Red	ON/OFF	250
DBLB19F-LEDB	Blue	ON/OFF	250
DBLB19F-LEDW	White	ON/OFF	250



## Illuminated Rocker Switch

IP65 ▪ ON/OFF Function ▪ 6A 250V AC ▪ Illuminated ▪ Dust Proof

MODEL	DESCRIPTION	M. CARTON
DBRS1	Rocker Switch	100



\* Images displayed are for illustration purposes only and may differ from actual photos

## Universal Aluminum 1" Spacer for LED Light Bars

MODEL	DESCRIPTION	M. CARTON
DBLBS1	1" Universal Aluminum Spacer	150

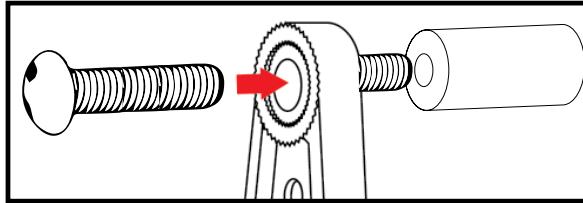

## LED Strip Roll

- Super Bright LED
- Easy Installation
- 12 volt Self-Adhesive backing
- 5 Meters / 16 ft.

MODEL	COLOR	LED AMOUNT	LED TYPE	IP RATING	M. CARTON
DBLEDR-W300	White	300	5050	66	50
DBLEDR-R300	Red	300	5050	66	50
DBLEDR-B300	Blue	300	5050	66	50
DBLEDR-W150	White	150	5050	66	50
DBLEDR-R150	Red	150	5050	66	50
DBLEDR-B150	Blue	150	5050	66	50

Contact Us (877) 787 - 0101



L.E.D. LIGHT BAR ACCESSORIES / L.E.D. LIGHT ROLLS

\* Images displayed are for illustration purposes only and may differ from actual photos

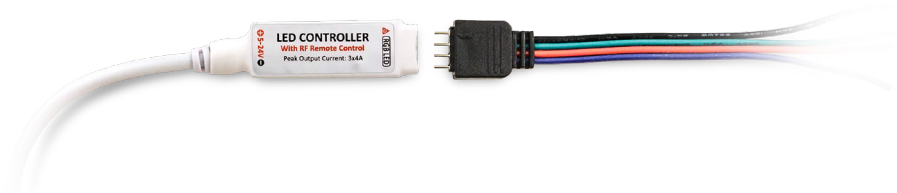

## DBLRGBC RGB LED Roll Remote Control

- Switchable LED colors ▪ Switchable LED patterns ▪ Adjustable pattern speed ▪ Adjustable Brightness
- Long Range Radio Frequency Wireless Remote

MODEL	DESCRIPTION	UPC	M. CARTON
DBLRGBC	RGB Controller	81021902179	600

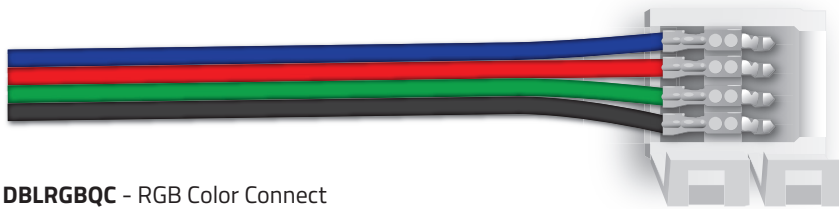

DBLRGBQC - RGB Color Connect

## LED Roll Quick Connect 10 pieces per bag

MODEL	DESCRIPTION	M. CARTON
DBLRGBQC	RGB Connect	50
DBLSRQC	Single Color Connect	50

## DBLSM-1 Universal LED Strobe Light Module

Strobe light module with dual output and 7 selectable flash patterns. Double, quad, quint and mega alternating, double simultaneous, quad simultaneous and random.

**Voltage:** 12 volts

**Outputs:** 2

**Amperage Output:** 3 Amps per Output

**Maximum Amperage:** 6 Amps

Total Across both Outputs

**Output Polarity:** 12V Positive

M. CARTON - 200

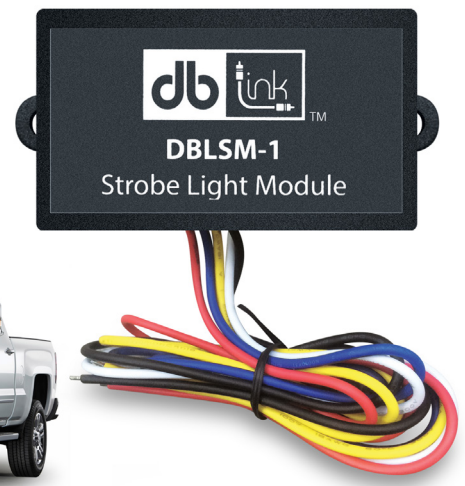



\* Images displayed are for illustration purposes only and may differ from actual photos



## LED Module Strips Packaged: One 10 Module Strip per bag

▪ IP65 Water Resistant design ▪ High output LED ▪ Easy Mounting ▪ Low power consumption ▪ 10 Modules per strip  
 Recommended for use in store displays, custom car audio installations, marine accent lighting, mood lighting for rooms, fish aquariums, or anywhere you need custom lighting. Not designed to be submerged under water.

MODEL	COLOR	LED AMOUNT	SIZE	LUMENS	M. CARTON
DBM10W-3L50	white	3 per module	5050	22	100
DBM10B-3L50	blue	3 per module	5050	22	100

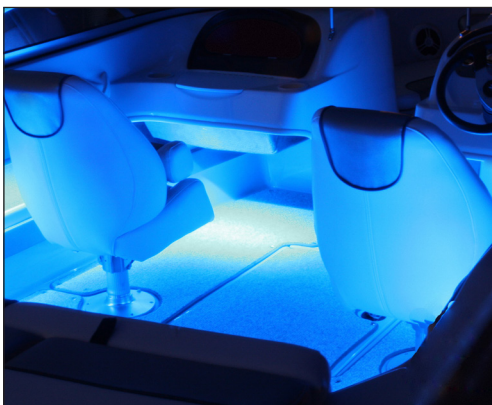

▪ Marine accent lighting applications

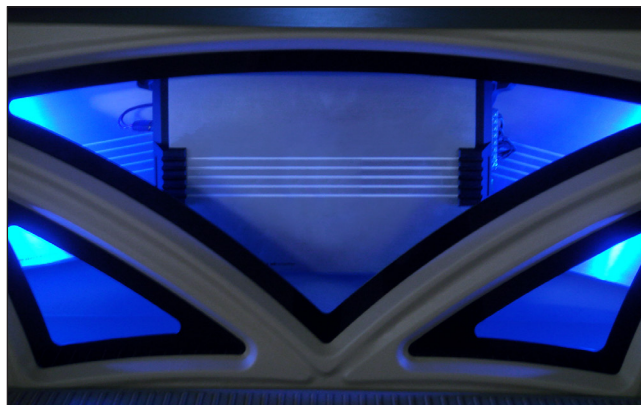

▪ Car Audio accent lighting applications

Contact Us (877) 787 - 0101



**L.E.D. MODULES**

\* Images displayed are for illustration purposes only and may differ from actual photos



## LED Spot Module Strips Packaged: 10 Pieces per Color

▪ High output LEDs ▪ Easy Mounting ▪ Low power consumption ▪ 5 LEDs per module  
 Recommended for use in custom car audio installations, marine accent lighting, mood lighting for rooms, fish aquariums, store displays, or anywhere you need custom lighting. Not designed to be submerged under water.

MODEL	COLOR	LED AMOUNT	M. CARTON
DBM1W	white	5 per module	100
DBM1B	blue	5 per module	100
DBM1R	red	5 per module	100
DBM1P	pink	5 per module	100
DBM1G	green	5 per module	100

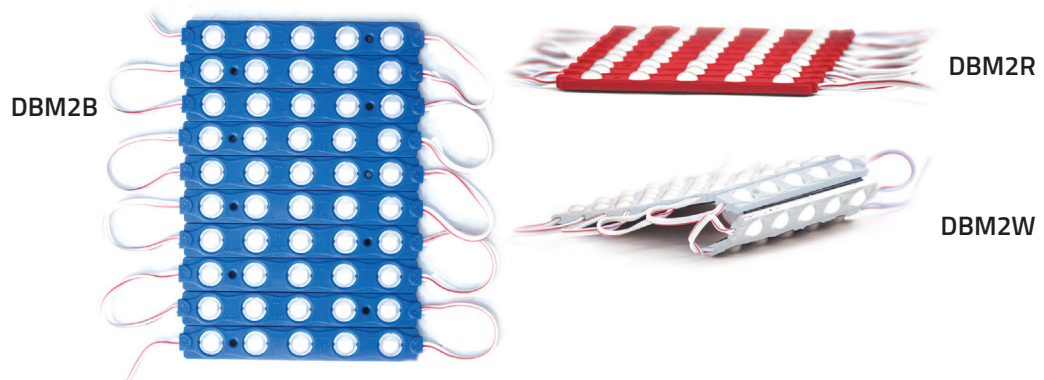

## LED Flood Module Strips Packaged: 10 Pieces per Color

▪ High output LEDs ▪ Easy Mounting ▪ Low power consumption ▪ 5 LEDs per module  
 Recommended for use in custom car audio installations, marine accent lighting, mood lighting for rooms, fish aquariums, store displays, or anywhere you need custom lighting. Not designed to be submerged under water.

MODEL	COLOR	LED AMOUNT	M. CARTON
DBM2W	white	5 per module	100
DBM2B	blue	5 per module	100
DBM2R	red	5 per module	100

\* Images displayed are for illustration purposes only and may differ from actual photos

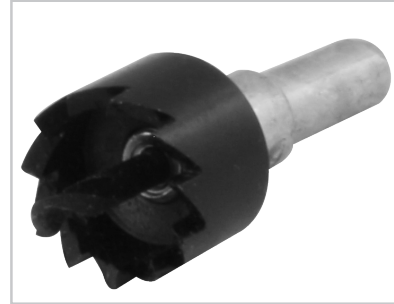

Drill Bit Included

## LED Ghost light Logo

23 Auto Manufacturer Logos Included

Designed to turn heads and be the life of the party. WOW them all with LED ghost lights. Mount two LED ghost lights in to your vehicle doors that project your favorite car brand logos via high resolution LEDs on to the pavement.

MODEL	DESCRIPTION	M. CARTON
DBLGL50	LED Ghost light Logo	100



Contact Us (877) 787 - 0101

**db link** LIGHTING SOLUTIONS

**LED. GHOST LIGHT**



**LIGHTING SOLUTIONS**

Jeep, Ford, Toyota, Dodge, GMC, Chevrolet are registered trademarks, logos and trade names that are mentioned in this catalog are the property of their respective owners. DB Research L.L.P. has no affiliation with these companies and this catalog is not endorsed by them.



302 Hanmore Industrial Parkway/Harlingen, TX 78550  
Toll Free: (877) 787-0101 Fax: (956) 421-4513  
sales@dbdrive.net  
Printed in China  
Model # LEDCAT23A



[www.DBLINKLIGHTINGSOLUTIONS.com](http://www.DBLINKLIGHTINGSOLUTIONS.com)